

# CLIFF

## 1KV CROCODILE CLIP

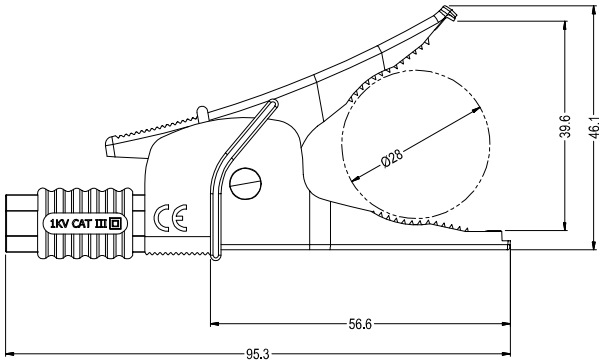

EN61010 1KV CAT III compliant Croc Clip. Current rating 20A.



1KV Crocodile Clip

4mm Socket at rear accepts Shrouded Plugs

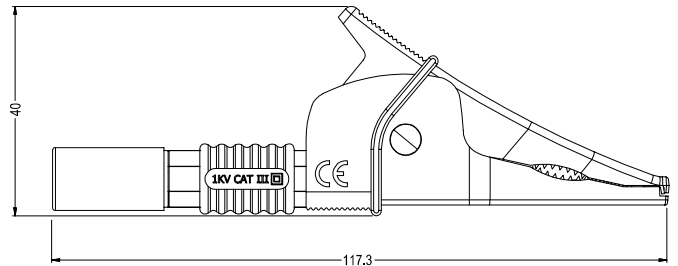

1KV Extended Crocodile Clip

Extended Rear Shroud version for use with Unshrouded Plugs

**Part No.**

**1KV Croc Clip**

- FCR79900B** BLACK
- FCR79900G** GREEN
- FCR79900L** BLUE
- FCR79900N** BROWN
- FCR79900R** RED



Available in 5 colours

**Part No.**

**1KV Extended Croc Clip**

- FCR79910B** BLACK
- FCR79910G** GREEN
- FCR79910L** BLUE
- FCR79910N** BROWN
- FCR79910R** RED

TPR/2 Croc Clip attachment to convert into a Fused Croc Clip for direct cable connection or 4mm Socket connection (as shown below).



Available in 5 colours



## 1KV CROCODILE CLIP

### Key Features / Product Overview

- Compatible with universal standard 4 mm shrouded plugs
- Conforms to EN61010-031
- IEC Measurement Category III - CAT III equipment is designed for measurements performed in the building installation.

### Technical Specifications

- Croc Clip – 1kV AC/DC 20A CAT III  (Double Insulated)
- Designed to comply with EN61010-031
- Environmental ratings: -10 °C to 40 °C (14 °F to 104 °F), altitude: 2000 m (6,562 ft)
- Not for permanent or semi-permanent connection.

### Warnings and Description of Markings

Double or Reinforced Insulation 

Caution 

UK Conformity Assessed

Conformité Européenne

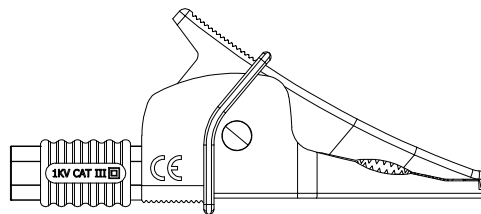

### To prevent electric shock or personal injury:

- The MEASUREMENT CATEGORY of a combination of a probe assembly and an accessory is the LOWER of the MEASUREMENT CATEGORIES of the probe assembly AND of the accessory.
- It is the end user's responsibility to ensure this device is used in a safe manner to ensure no injury is caused to operators. Failure to follow these instructions or use this equipment in a manner not specified by the manufacturer, could impair the safety of the equipment.
- Protect the leads and accessories from damage, e.g., cuts and abrasions. Keep clean and dry.
- Before use check the assembly for damage - If in doubt DO NOT USE.
- Equipment, test leads and accessories should be inspected and tested regularly during their life to ensure the integrity of the insulation and that their continuity has not been compromised. If in doubt, contact the manufacturer for advice.
- DO NOT change accessories while connected to live or potentially live circuits
- Check the protection features, fusing and safety ratings of the test meter itself are compatible before using with these test leads.
- Clean with a soft towel moistened with water and mild detergent. (DO NOT IMMERSE in liquid).
- The croc clip does not contain any serviceable parts. If in doubt please contact the manufacturer, DO NOT attempt to service the probe assembly.
- DO NOT USE in wet or damp locations.
- DO ENSURE that the test leads are firmly connected to the instrument and other accessories.
- DO NOT USE above the maximum ratings.
- DO NOT USE the croc clip if the insulation around the jaws or 4mm socket are damaged or worn.

For further information, contact [sales@cliffuk.co.uk](mailto:sales@cliffuk.co.uk)

**Cliff Electronic Components Limited,**  
76 Holmethorpe Avenue, Holmethorpe Ind. Estate,  
Redhill, Surrey RH1 2PF U.K.  
Tel: +44 (0)1737 771375 Fax: +44 (0)1737 766012

[www.cliffuk.co.uk](http://www.cliffuk.co.uk)



# CLIFF

## 1KV CROCODILE CLIP

### Key Features / Product Overview

- Compatible with Cliff Test Probes TPR1 & TPR1C incorporating a 4mm lantern probe tip connector.
- Conforms to EN61010-031
- IEC Measurement Category III - CAT III equipment is designed for measurements performed in the building installation.

### Technical Specifications

- Croc Clip – 1kV AC/DC 20A CAT III  (Double Insulated)
- Designed to comply with EN61010-031
- Environmental ratings: -10 °C to 40 °C (14 °F to 104 °F), altitude: 2000 m (6,562 ft)
- Not for permanent or semi-permanent connection.

### Warnings and Description of Markings

Double or Reinforced Insulation 

Caution 

UK Conformity Assessed



Conformité Européenne

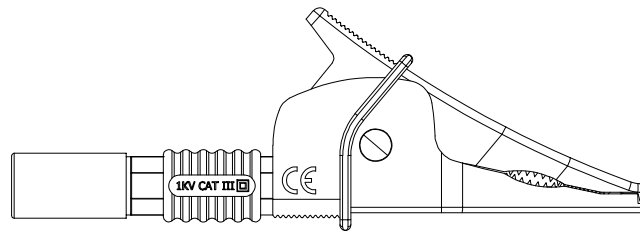

### To prevent electric shock or personal injury:

- The MEASUREMENT CATEGORY of a combination of a probe assembly and an accessory is the LOWER of the MEASUREMENT CATEGORIES of the probe assembly AND of the accessory.
- It is the end user's responsibility to ensure this device is used in a safe manner to ensure no injury is caused to operators. Failure to follow these instructions or use this equipment in a manner not specified by the manufacturer, could impair the safety of the equipment.
- Protect the leads and accessories from damage, e.g., cuts and abrasions. Keep clean and dry.
- Before use check the assembly for damage - If in doubt DO NOT USE.
- Equipment, test leads and accessories should be inspected and tested regularly during their life to ensure the integrity of the insulation and that their continuity has not been compromised. If in doubt, contact the manufacturer for advice.
- DO NOT change accessories while connected to live or potentially live circuits
- Check the protection features, fusing and safety ratings of the test meter itself are compatible before using with these test leads.
- Clean with a soft towel moistened with water and mild detergent. (DO NOT IMMERSE in liquid).
- The croc clip does not contain any serviceable parts. If in doubt please contact the manufacturer, DO NOT attempt to service the probe assembly.
- DO NOT USE in wet or damp locations.
- DO ENSURE that the test leads are firmly connected to the instrument and other accessories.
- DO NOT USE above the maximum ratings.
- DO NOT USE the croc clip if the insulation around the jaws or 4mm socket are damaged or worn.